

# Thermal desorption comprehensive two-dimensional gas chromatography for in-situ measurements of organic aerosols

Allen H. Goldstein<sup>a,\*</sup>, David R. Worton<sup>a</sup>, Brent J. Williams<sup>a</sup>, Susanne V. Hering<sup>b</sup>,  
Nathan M. Kreisberg<sup>b</sup>, Ognjen Panić<sup>c</sup>, Tadeusz Górecki<sup>c</sup>

<sup>a</sup> Department of Environmental Science, Policy, & Management, University of California,  
151 Hilgard Hall, Berkeley, CA 94720, USA

<sup>b</sup> Aerosol Dynamics Inc., 935 Grayson St., Berkeley, CA 94710, USA

<sup>c</sup> Department of Chemistry, University of Waterloo, Waterloo, Ontario N2L 3G1, Canada

Available online 22 October 2007

## Abstract

The complexity of organic composition and temporal variability of atmospheric aerosols presents an extreme analytical challenge. Comprehensive two-dimensional gas chromatography (GC × GC) has been used on time integrated filter samples to reveal the presence of thousands of individual organic compounds in aerosols, but without defining the temporal variability in composition ideal for providing information on source resolution and human exposure to specific pollutants. We hereby introduce a new instrument, 2D-TAG, which combines our in-situ thermal desorption aerosol GC (TAG) instrument with GC × GC allowing for dramatically improved separation of organics with automated measurements at hourly timescales. © 2007 Elsevier B.V. All rights reserved.

**Keywords:** Organic aerosol; Mass spectrometry; Two dimensional chromatography

## 1. Introduction

Organic matter is a major constituent of atmospheric aerosols, comprising 20–80% of the mass of PM<sub>2.5</sub>, defined as particulate matter with diameters smaller than 2.5 μm [1–6]. Its chemical composition is complex and largely not understood. Identification of its components is critical for tracing sources, elucidating transformation and formation processes, evaluating effects on human health, and assessing effects on global climate, both through direct scattering and as sources of cloud condensation nuclei.

Until recently, the identification and quantification of specific organic compounds in aerosols has involved integrated sample collection by filtration or impaction with subsequent extraction and analysis by liquid or gas chromatography. With these methods, hundreds of individual compounds have been identified in atmospheric aerosols [7–12]. Identified compounds include alkanes, substituted phenols, aldehydes, sugar derivatives, poly-

cyclic aromatic hydrocarbons, mono- and dicarboxylic acids. More recently, application of two dimensional chromatographic analyses [13] has enabled the identification of thousands of individual compounds.

While these identified compounds only comprise a fraction of the total organic mass, those that are quantified serve as valuable tracers for sources. For example, hopanes are remnants of the biological material from which petroleum originated and serve as a unique tracer for fossil fuel combustion. Retene, a branched polyaromatic hydrocarbon (PAH), is a unique tracer for wood combustion. Biogenic alkanes are distinguished from fossil derived alkanes through a carbon preference number that reflects the predominance of odd carbon number alkanes in plant waxes. These types of unique characteristics in organic compound origins have been used to estimate the relative contribution of various source types to organic aerosols in the atmosphere [3,14–17].

### 1.1. TAG

Our approach has been to combine thermal desorption with traditional GC/MS analyses in an automated, in-situ instrument.

\* Corresponding author. Tel.: +1 510 643 2451.

E-mail address: [ahg@nature.berkeley.edu](mailto:ahg@nature.berkeley.edu) (A.H. Goldstein).

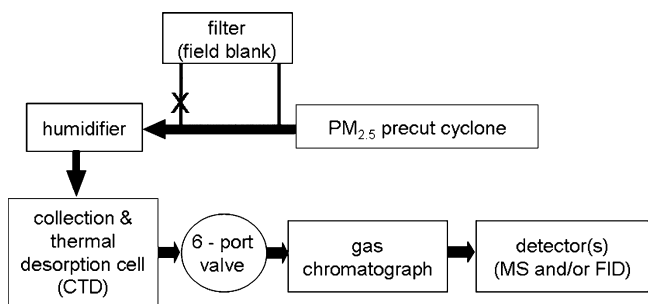

Fig. 1. Schematic of the thermal desorption aerosol GC (TAG) in-situ instrument for hourly measurements of organic compounds in atmospheric samples.

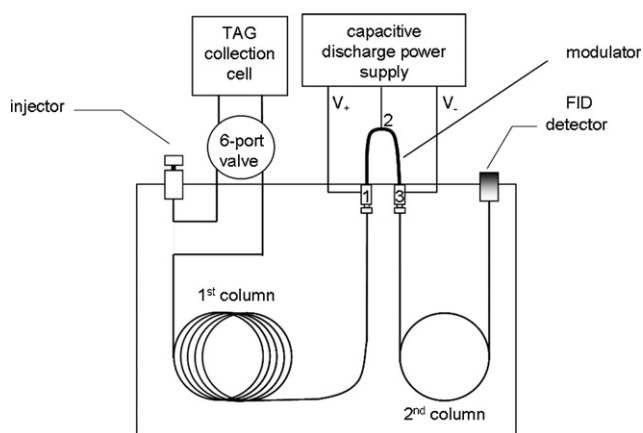

Fig. 2. 2D-TAG instrument employing a two-stage air-cooled thermal modulator controlled by application of periodic current pulses for heating, with cooling by a forced air stream at ambient conditions (not shown).

We developed this method to provide hourly time resolved organic speciation for ambient aerosols. Our instrument, the thermal desorption aerosol gas chromatography–mass spectrometry (TAG) system, combines an impactor particle collector with thermal desorption GC/MS to provide identification and quantification of organic constituents at the molecular level [6,18]. Many of the eluting compounds have been identified by using authentic standards or by matching measured mass spectra to reference spectra from the US National Institute of Standards

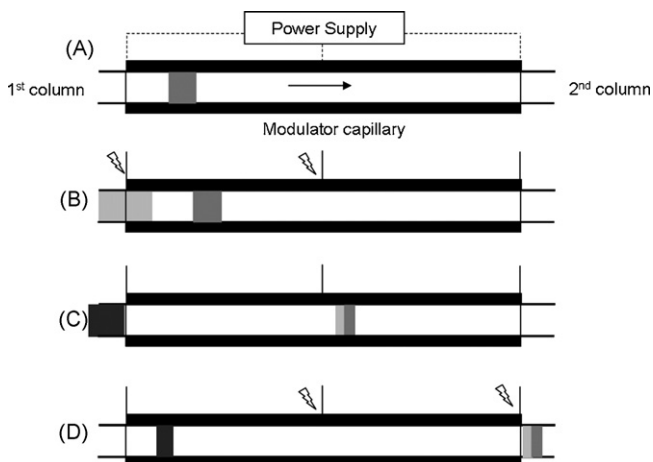

Fig. 3. Schematic illustration of the two stage thermal modulator operation.

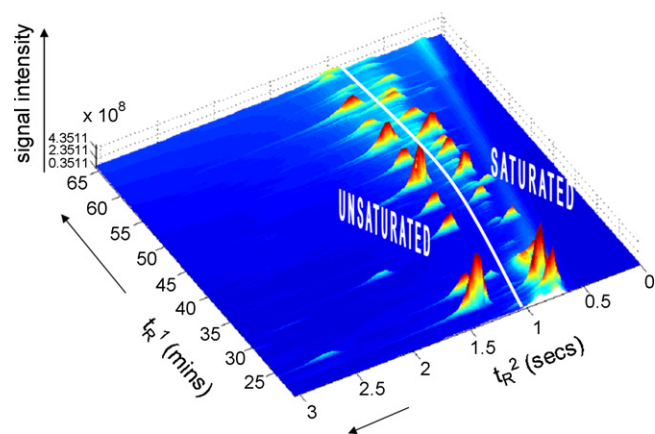

Fig. 4. 2D-TAG chromatogram of fatty acid methyl esters standard, injecting 2–5 ng/compound. The saturated and unsaturated acid esters are clearly separated in the second dimension due to the slight increase in polarity from the presence of a carbon double bond.

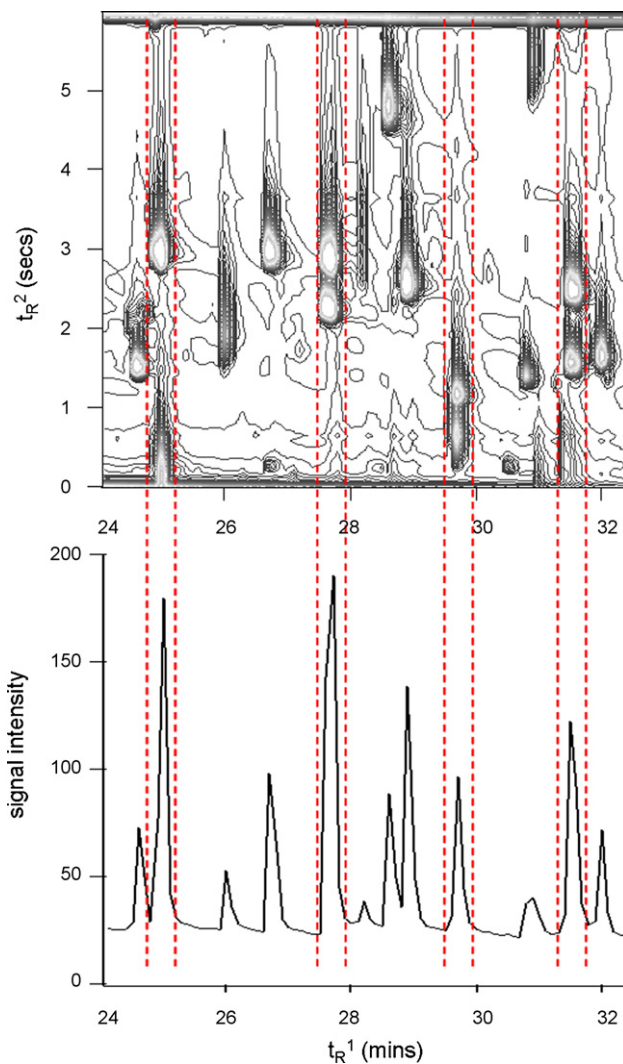

Fig. 5. Portion of a 2D chromatogram for the EPA 8270 authentic standard (upper panel), with comparison to the reconstructed 1D signal (lower panel). Note that many peaks including the tallest peaks in the 1D chromatogram are revealed to be multiple compounds in the 2D as indicated by the dashed lines.

and Technology (NIST) database. Those identified include alkanes, aldehydes, ketones, PAHs, monocarboxylic acids, and many more.

In this paper, we report development of a new version of our automated, in-situ instrument for the time-resolved measurement of organic compounds in ambient aerosols utilizing a comprehensive two dimensional chromatographic separation. This instrument, the thermal desorption aerosol GC  $\times$  GC (2D-TAG), is a modified version of our single-dimension TAG instrument (1D-TAG) with dramatically improved separation capabilities for the organic compounds present in atmospheric aerosols.

The comprehensive two-dimensional GC (GC  $\times$  GC) technique uses two chromatography columns with different stationary phases connected in series and separated by a modulator. The modulator periodically traps analytes eluting from the first column, and injects fractions of this effluent onto the second column in the form of narrow pulses provid-

ing additional separation for co-eluting peaks. The GC  $\times$  GC technique offers many advantages over conventional 1D chromatography including: (i) increased resolution, (ii) structured chromatograms, and (iii) enhanced sensitivity [19]. Hamilton et al. [20] and Welthagen et al. [13] have analyzed filter samples of ambient PM<sub>2.5</sub> aerosol by thermal desorption coupled to GC  $\times$  GC. Their work showed that the GC  $\times$  GC approach could be used to separate over 10,000 individual organic components in a single procedure with no sample pre-treatment. The range of compounds includes alkanes to poly-oxygenated species and acids, similar to our current TAG instrument, but the added separation provided by GC  $\times$  GC makes it possible to separate, identify and quantify significantly more compounds. In this paper, we introduce a new instrument, 2D-TAG, which combines our automated in-situ TAG instrument with GC  $\times$  GC allowing for dramatically improved separation of aerosol organics with automated measurements at hourly timescales.

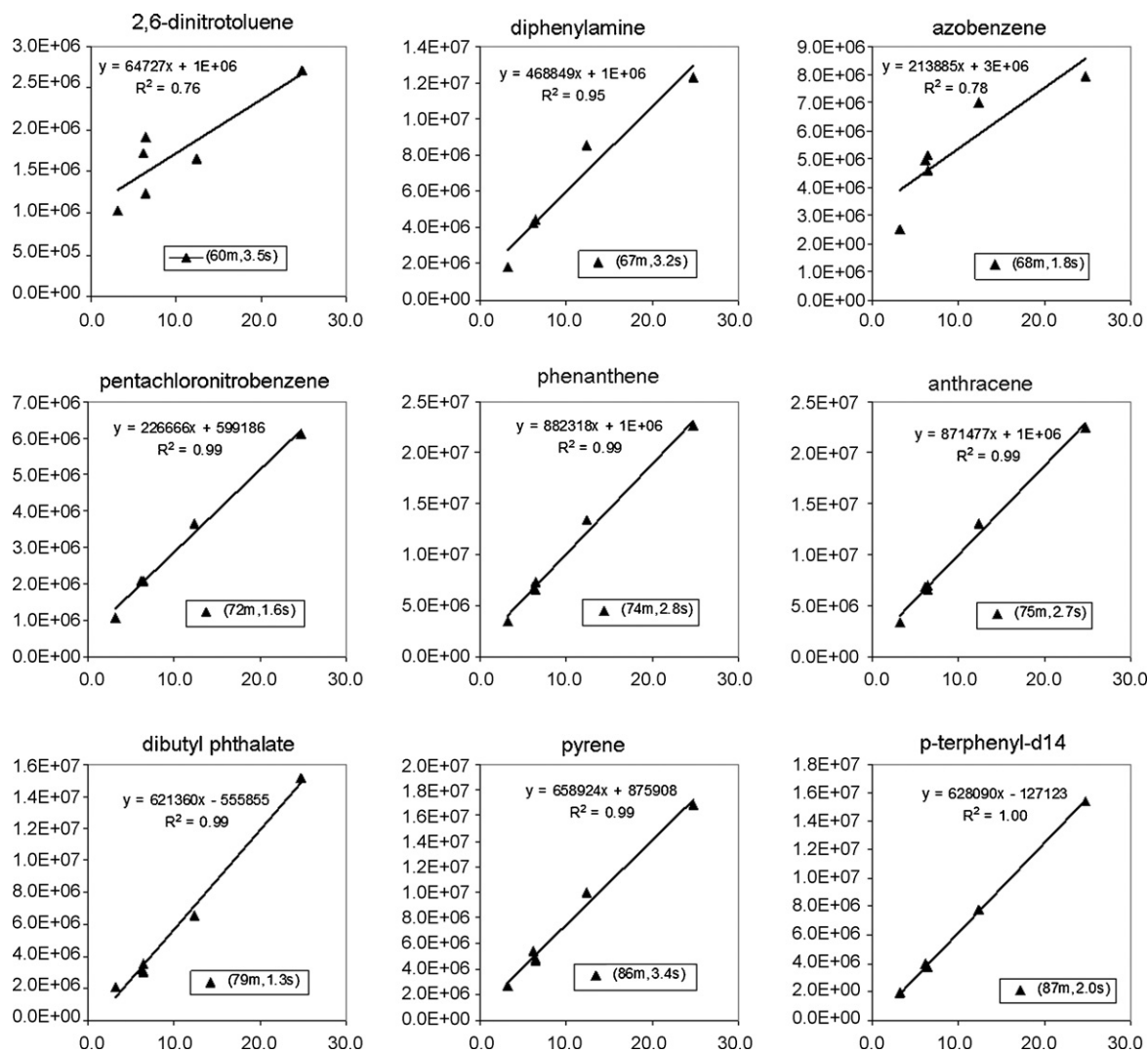

Fig. 6. Linearity of the 2D-TAG system as indicated by peak areas (y-axis) versus concentration in nanograms (x-axis) for 9 of the compounds in the EPA Method 8270 authentic standard solutions injected directly into the collection cell. Retention times (primary, secondary) are given along with linear regression results for each compound.

## 2. Experimental

The TAG system is shown schematically in Fig. 1. Typically, it operates on a 1-h cycle with 30 min of sample collection at a flow rate of 8.5 L/min, giving a total sample volume of 0.25 m<sup>3</sup>. Particles are deposited into the collection and thermal desorption (CTD) cell by impaction, followed by thermal desorption onto a GC column, with subsequent detection by MS and a flame ionization detection (FID) system. During the analysis the collection cell is cooled, and the next sample collected. The impaction collector is preceded by a cyclone to exclude particles above 2.5 μm and by a humidifier to minimize loss by bounce and re-entrainment. A 6-port valve heated to 300 °C separates the collection cell from the GC/MS-FID system (6890 Agilent GC with 5973 Agilent quadrupole MS). Dynamic filter blanks are obtained on a pre-programmed schedule by automatically switching a PTFE filter inline upstream of the humidifier. During desorption the valve and transfer lines are heated, while the column is held at 45 °C, acting as a “cold trap” that focuses the desorbed compounds onto the head of the column. For 1D-TAG, the typical chromatographic column we have used was Rtx5-MS (Restek, Bellefonte, PA, USA) with helium as the carrier gas and the column effluent split between an FID and a quadrupole MS.

Adaptation of our 2D-TAG system required the addition of a thermal modulator, and the incorporation of a secondary column operating in series with the primary column (Fig. 2). It also requires a fast scanning detector, and therefore in this initial version of 2D-TAG, detection was done with FID alone (without the quadrupole MS). For the primary column we have used a Varian Factor Four VF-5ms (30 m × 0.25 mm, 1 μm) to achieve an initial separation based on the compounds’ volatility, and for the secondary column we have used Solgel Wax (SGE, 1.4 m × 0.25 mm, 0.25 μm) to achieve separation based predom-

inantly on the compounds polarity. This pair of columns provide a separation that attempts to maximize the chromatographic resolution of a wide range of individual compounds.

The modulator employed in our 2D-TAG system is a custom-made, air-cooled two-stage thermal modulator and does not require any consumables making it appropriate for an automated in-situ field instrument. It is placed between the two columns and is mounted just outside the GC oven to allow for continuous forced air cooling. The modulator is based on previous work by Liu and Phillips [21] and Harynuk and Górecki [22] and consists of a 15 cm segment of Silcosteel tubing (Restek) internally coated with a thin layer of polydimethylsiloxane (PDMS) stationary phase. Initially, the PDMS film thickness used was 3 μm although currently we are working with both 1 μm and a deactivated Silcosteel trapping capillary. Dual stage modulation is achieved through alternatively heating the two segments of the trapping capillary using a custom built capacitive discharge power supply. The timing of the desorption events are synchronized with the data acquisition clock of the detector. This synchronization is important for generating highly reproducible GC × GC chromatograms since the phasing of the modulation can have a significant impact on the appearance of the primary dimension separations and peak heights observed at the detector [19]. In order to preserve the separation achieved in the first dimension, each peak eluting from the primary column should be sampled at least 2.5–3 times [19,23,24]. Therefore, to achieve this we used a 6 s modulation period and reduced the oven temperature ramp to 3 °C/min, resulting in longer analysis times (120 min) for 2D-TAG relative to those typically used for 1D-TAG (60 min).

The operation of the modulator is illustrated in Fig. 3. As bands of analytes from the primary column enter the modulator, they partition into the thick film of the stationary phase at ambi-

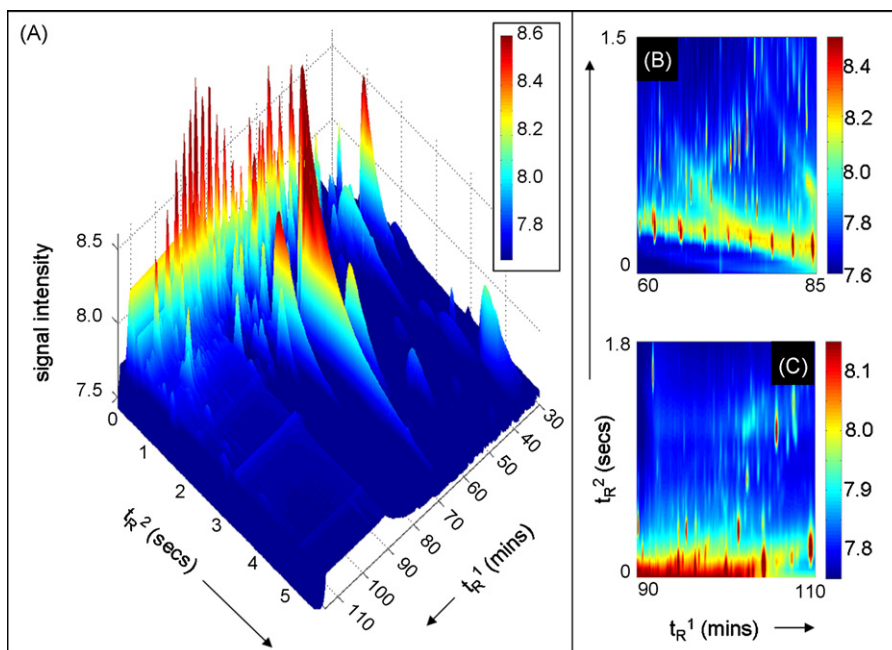

Fig. 7. 2D-TAG chromatogram of a 90 min ambient air sample collected in Berkeley, CA on 25 February 2007 (panel A). Enlargements of two regions (labeled B and C) are also shown in the right panel to illustrate the good peak shapes and observable banding structure indicative of compound classes.

ent temperature, becoming trapped and focused as a result of zonal compression (Fig. 3A). The trapped analytes are rapidly desorbed by resistively heating the first segment of the trapping capillary (between contacts 1 and 2 in Fig. 2) and become trapped and refocused in the second segment of the trap (between contacts 2 and 3 in Fig. 2). This is illustrated in Fig. 3B and C, respectively. Next, the analytes in the second stage of the modulator are thermally desorbed and injected onto the second dimension column as a narrow band. Simultaneously, analyte breakthrough is prevented as the cooled first stage of the modulator once again enables trapping of the first dimension effluent (Fig. 3D). This cycle is referred to as dual stage modulation and is repeated throughout the entire GC  $\times$  GC analysis (Fig. 3).

The peak widths in GC  $\times$  GC are significantly narrower than those in 1D GC because thermal focusing associated with the modulation cycle leads to the injection of narrow bands onto the second column. This leads to more than an order of magnitude improvement in the signal to noise ratio relative to 1D and arises because the same mass of a compound is seen by the detector in a much shorter period of time (e.g. <1 s versus  $\sim$ 20 s). In order to accurately capture the peak shapes, a fast scanning detector with a data acquisition rate of at least 50 Hz is required. The quadrupole MS used for 1D TAG had a scanning rate of only 2 Hz. The initial version of our 2D-TAG instrument presented here used FID only, with a scanning rate more than 50 Hz. Subsequent work will incorporate time-of-flight

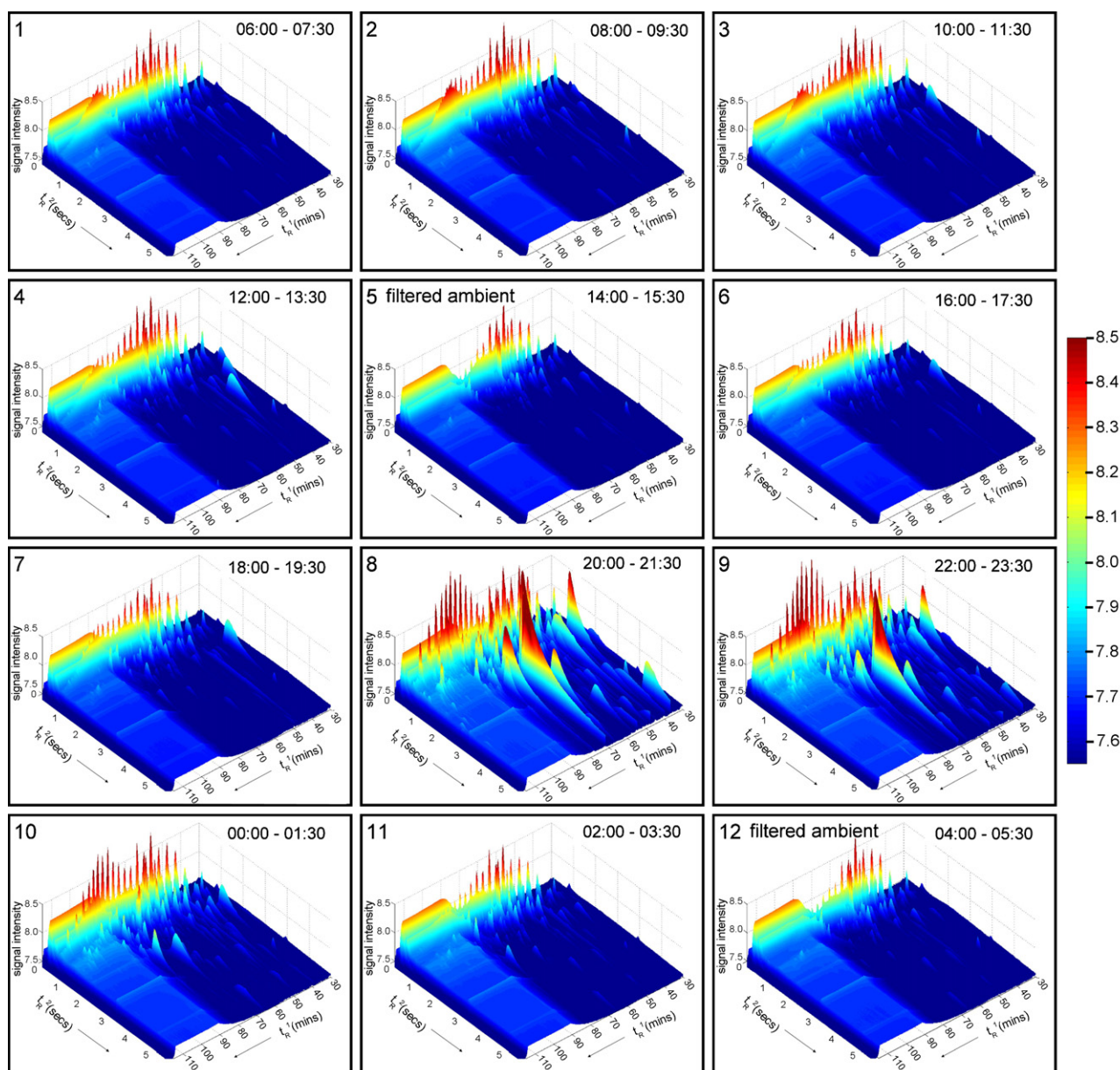

Fig. 8. 2D-TAG chromatograms of ambient air collected at 2 h intervals over a 24 h period in Berkeley, CA on 25 and 26 February 2007. The panel numbers are shown in the top left and the sampling time periods in the top right corners of each panel. Panels 5 and 12 are filtered ambient air samples and show the presence of non-particle gas phase semi-volatile species, that are collected in the collection and thermal desorption cell during sampling. A larger view of panel 8 is shown in Fig. 7.

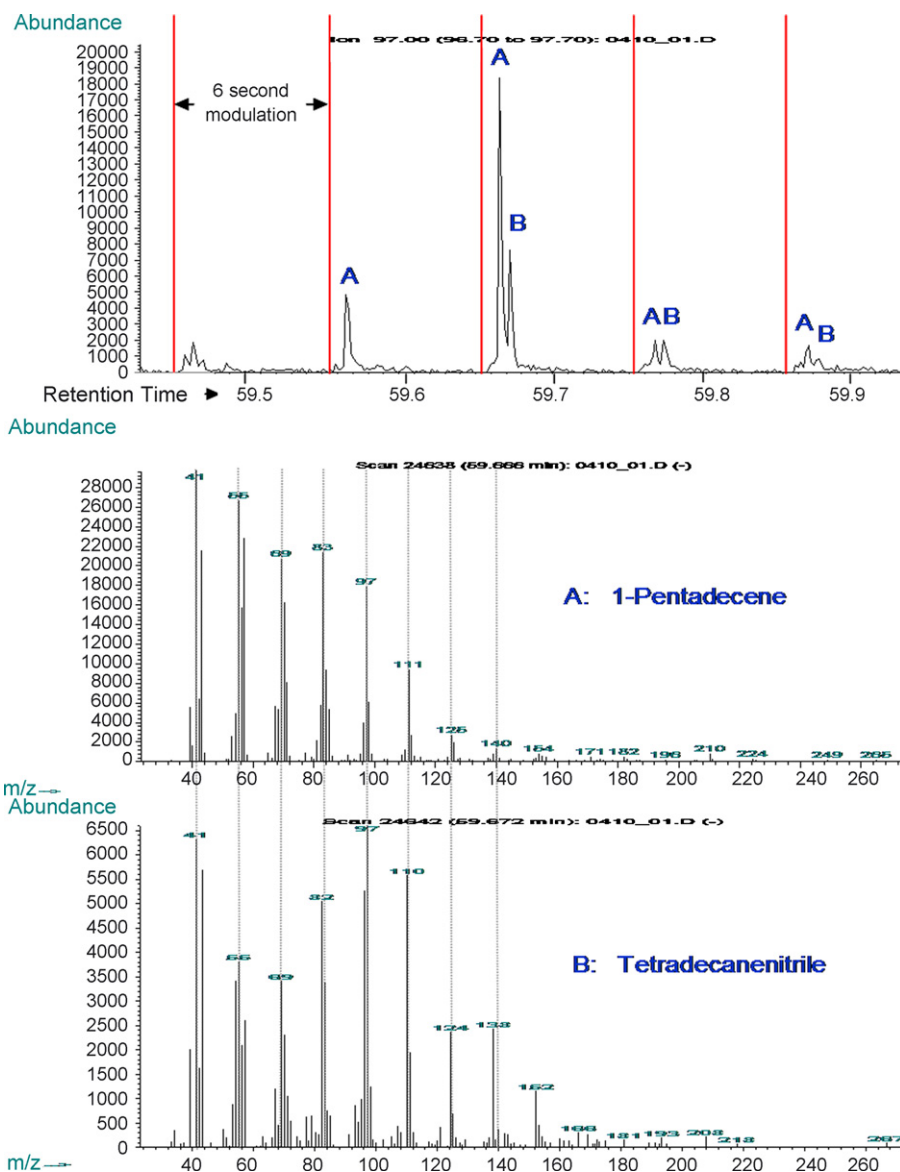

Fig. 9. Short segment of a chromatogram from an ambient air sample collected on 4/9/06–4/10/06 in Berkeley, CA, USA, using 2D-TAG. Top: time line of the elution of  $m/z = 57$  from the secondary column, with vertical lines indicating the modulation period of 6 s, showing four modulations of compound A (1-pentadecene) and three modulations of compound B (tetradecanenitrile). These compounds are clearly separated (mass spectra shown in middle and bottom panels, respectively) by GC  $\times$  GC but would not have been separated by 1D GC.

(TOF) MS for mass spectral analysis at similarly fast scanning rates.

### 3. Results and discussion

The evaluation of 2D-TAG was done systematically, first with simple standard mixtures introduced via syringe through the traditional GC injection port and then by desorption of standards directly from the TAG CTD cell. Initial tests were conducted while the two columns and modulator were in place, but without modulation. This allowed us to evaluate the performance of the modified system in a one-dimensional chromatography mode. Standards were introduced through the GC injection port while bypassing the TAG CTD cell and 6-port valve. Next, the same standards were run with modulation. Next the

6-port valve was added back into the system. Finally, once we had ensured that the modulator was performing properly when operated using the injection port, we tested the TAG configuration by desorbing standards directly from the CTD cell.

#### 3.1. Liquid standards

Standards were introduced by a microliter syringe via an injection port built into the collection cell following the procedure we use for routine in-situ calibrations of the TAG system [25]. As with the original TAG system, care is taken to ensure all transfer lines and the 6-port valve are heated and deactivated for efficient analyte transfer. Each of these different configurations resulted in similar chromatograms establishing that equivalent

results were achieved between the GC injector and CTD described standards.

Fig. 4 shows a chromatogram from 2D-TAG for a fatty acid methyl ester standard mixture at the 2–5 ng/compound level. This surface plot, clearly shows a separation of the saturated from the unsaturated fatty acid esters, demonstrating the power of the added chromatographic dimension. The unsaturated compounds have an increase in polarity that is sufficient to separate and thereby classify a subset of otherwise very similar compounds. Another example that illustrates the improved separation power of 2D-TAG over 1D is shown in Fig. 5, which compares a portion of both the 2D and 1D chromatograms for the US Environmental Protection Agency (EPA) Method 8270 authentic standard. This is a mix of 116 semi-volatile organic compounds (boiling point range of 150–500 °C) found in the environment. These are mostly aromatic compounds encompassing many different sub-classes including PAHs, chlorinated hydrocarbons, phthalate esters, phenols, nitroaromatics, nitrosamines, haloethers, organochlorine pesticides, and polychlorinated biphenyls (PCBs). The upper panel of Fig. 5 shows a 2D contour plot relative to the reconstructed signal for material eluting from the primary column (i.e., the equivalent, one-dimensional signal) in the lower panel. A particularly informative example of the improved separation is the tallest peaks in the 1D chromatogram, which are seen to actually be the sum of two co-eluting compounds that are clearly separated in the second dimension.

### 3.2. Linearity of response

The EPA Method 8270 standard was introduced at four levels, with injections into the CTD cell ranging from 3 to 25 ng per compound. For nine of these compounds, the FID signals were integrated over all four injection levels, and are presented as scatter plots and linear regressions in Fig. 6. The selected compounds represent a range of primary and secondary retention times: 60–87 min and 1.6–3.5 s, respectively. Primary and secondary retention times are shown for each compound in the form “( $t_R^1$  in min,  $t_R^2$  in s)”. For all but the earliest primary retention times the responses are linear, with correlation coefficients of greater than or equal to 0.99 for retention times later than 72 min. Earlier retention times represent higher volatility compounds that are inherently more susceptible to variable losses during the spiking and thermal desorption process.

### 3.3. Ambient aerosol

Fig. 7A shows the 2D-TAG measurement of a 90 min ambient sample taken in Berkeley, CA on 25 February 2007 during the early evening. There is a “fence post” of low polarity compounds, consistent with standards we have analyzed for a series of alkanes containing between 13 to nearly 40 carbon atoms, which are evenly separated along the primary dimension as the number of carbon atoms in the molecule increases. Compounds that would have been unresolved by 1D-TAG appear spread throughout the 2D space showing that co-eluting organic aerosol compounds off of the primary column (i.e. those peaks

falling within a narrow band) are indeed separated in the second dimension. At the scale shown in Fig. 7A, hundreds of individual compounds are clearly separated. At a finer scale many more compounds are separated. The large observed tailing for the hexadecanoic and octadecanoic acid peaks at  $t_R^1 = 71.5$  and 78 min,  $t_R^2 = 2.5$  and 2 s, respectively, are typical of the behaviour of acid compounds on this type of chromatographic system. Fig. 7B and C show two enlarged low polarity regions ( $t_R^2 \leq 2$  s), which illustrate more clearly the large number of compounds separated by the additional dimensions and also demonstrate the excellent chromatography with narrow, well resolved peaks being evident in both regions. There are also hints of banding structures, which result from different classes of compounds, in these enlarged chromatograms. These structures can be used to tentatively identify or at least classify compounds according to their chemical properties.

A sequence of 12 ambient aerosol measurements for samples collected at 2-h intervals in Berkeley, CA, USA from the 25–26 February is shown in Fig. 8. Again, a strong band of low polarity compounds, consistent with our alkane standards, is clearly seen at short secondary retention times ( $<0.5$  s) and is consistently observed throughout the primary dimension. This band is apparent throughout the 24-h period, with temporal changes in intensity. The *n*-alkanes are consistently a dominant component of this band and of the organic mass in the aerosol. Many compounds are seen that separate in the second dimension, especially in panels 8–10. A pair of compounds, hexadecanoic acid ( $t_R^1 = 72$  min,  $t_R^2 = 2.5$  s) and octadecanoic acid ( $t_R^1 = 78$  min and  $t_R^2 = 2$ ) are not seen in panel 7, appear and are dominant in panel 8, and become less dominant in panels 9 and 10. These two compounds and many other peaks, which are currently unidentified, were detected repeatedly at the same time of day for several consecutive days and are clearly indicative of a specific source type or types impacting aerosol composition.

### 3.4. 2D-TAG with quadrupole MS detection

We also tested 2D-TAG using our existing quadrupole MS. As discussed, 2D chromatography results in much faster peak elution (e.g. 0.2 s peak widths) compared to one-dimensional chromatography (e.g. 20 s peak widths), and presents stringent temporal requirements for the detection system. To capture the peak shape, achieve accurate integrations, and obtain non-skewed mass spectra of compounds eluting off of the second column for identifications; a minimum of five or six samples must be acquired per peak. With typical peak widths of about 200 ms, a data acquisition rate of  $\sim 30$  scans/s (Hz) is required. By minimizing the *m/z* scanning range to 30–300 U/s, we were able to measure scans at a rate approaching 10 Hz. While this is not adequate for quantification, we were able to collect mass spectra which could be used for identification purposes. The additional information provided by mass scans allows not only the identification of peaks in the chromatogram, but also the possibility of separating peaks which still overlap using their mass spectral characteristics.

A good example of the utility of GC  $\times$  GC combined with MS detection is for the measurement of alkenes and nitriles. These

compounds often overlap in 1D and have very similar MS fragmentation patterns, and thus are not distinguishable in 1D. Fig. 9 displays a portion of the chromatogram we obtained for an ambient sample with 2D-TAG coupled to our quadrupole. Although 1-pentadecene and tetradecanenitrile elute simultaneously from the primary column, the mass spectra showed how they were separated by the 2D-TAG chromatography system. These compounds would be completely co-eluting in a 1D chromatogram, but are measurable using 2D-TAG.

Future versions of the 2D-TAG instrument will utilize a TOF-MS as the detector and this will enable us to obtain full mass spectra for each of the peaks in these chromatograms with a high enough data acquisition rate to properly define the peak shape, allowing hourly identification and quantification of an unprecedented number of organic species in aerosols.

#### 4. Conclusions

We successfully coupled our TAG system with a comprehensive two-dimensional GC system (2D-TAG), using an air-cooled two-stage thermal modulator that does not require any consumables making it appropriate for an automated in-situ field instrument. The 2D chromatography provides drastically improved compound separation over 1D chromatography, as shown by clear separation of the saturated from the unsaturated fatty acid esters, and by the separation of many compounds in the EPA Method 8270 standard which co-elute in 1D. The complete 2D-TAG system was demonstrated to provide linear responses to specific target compounds, using four-point calibrations with the EPA Method 8270 standard. Analysis of ambient atmospheric aerosols demonstrates the 2D-TAG system provides considerable improvement in the separation of material that constitutes the unresolved mixture observed as an elevated baseline in 1D-TAG measurements. In particular, by using GC  $\times$  GC we are able to distinguish more polar compounds from their less polar counterparts of similar 1st dimension retention time, and thus separate an order of magnitude more compounds, with baselines returning to near zero for much of the 2D chromatogram.

#### Acknowledgements

This work was supported by the US Department of Energy STTR program, DEFG02-05ER-86235. Restek is gratefully

acknowledged for providing the Silcosteel<sup>®</sup> tubing free of charge. O.P. and T.G. acknowledge the financial support of the Natural Sciences and Engineering Research Council of Canada.

#### References

- [1] M.C. Jacobson, H.C. Hansson, K.J. Noone, R.J. Charlson, *Rev. Geophys.* 38 (2000) 267.
- [2] J.C. Chow, J.G. Watson, D.H. Lowenthal, P.A. Solomon, K.L. Magliano, S.D. Ziman, L.W. Richards, *Aerosol Sci. Technol.* 18 (1993) 105.
- [3] J.J. Schauer, G.R. Cass, *Environ. Sci. Technol.* 34 (2000) 1821.
- [4] C.S. Christoforou, L.G. Salmon, M.P. Hannigan, P.A. Solomon, G.R. Cass, *J. Air Waste Manage. Assoc.* 50 (2000) 43.
- [5] NARSTO, Particulate Matter Sciences for Policy Makers, A NARSTO Assessment, 2003.
- [6] B.J. Williams, A.H. Goldstein, D.B. Millet, R. Holzinger, N.M. Kreisberg, S.V. Hering, A.B. White, D.R. Worsnop, J.D. Allan, J.L. Jimenez, *J. Geophys. Res. Atmos.* 112 (2007) (Art. No. D10S26).
- [7] B.R.T. Simoneit, J.J. Schauer, C.G. Nolte, D.R. Oros, V.O. Elias, M.P. Fraser, W.F. Rogge, G.R. Cass, *Atmos. Environ.* 33 (1999) 173.
- [8] W.F. Rogge, L.M. Hildemann, M.A. Mazurek, G.R. Cass, B.R.T. Simoneit, *Environ. Sci. Technol.* 31 (1997) 2726.
- [9] W.F. Rogge, L.M. Hildemann, M.A. Mazurek, G.R. Cass, B.R.T. Simoneit, *Environ. Sci. Technol.* 31 (1997) 2731.
- [10] W.F. Rogge, L.M. Hildemann, M.A. Mazurek, G.R. Cass, B.R.T. Simoneit, *Environ. Sci. Technol.* 32 (1998) 13.
- [11] J.J. Schauer, M.J. Kleeman, G.R. Cass, B.R.T. Simoneit, *Environ. Sci. Technol.* 33 (1999) 1578.
- [12] C.G. Nolte, J.J. Schauer, G.R. Cass, B.R.T. Simoneit, *Environ. Sci. Technol.* 33 (1999) 3313.
- [13] W. Welthagen, J. Schnelle-Kreis, R. Zimmermann, *J. Chromatogr. A* 1019 (2003) 233.
- [14] M.P. Fraser, M.J. Kleeman, J.J. Schauer, G.R. Cass, *Environ. Sci. Technol.* 34 (2000) 1302.
- [15] P.M. Fine, G.R. Cass, B.R.T. Simoneit, *Environ. Sci. Technol.* 35 (2001) 2665.
- [16] Z.W. Yue, M.P. Fraser, *Atmos. Environ.* 38 (2004) 3253.
- [17] B. Buzcu, M.P. Fraser, *Atmos. Environ.* 40 (2006) 2385.
- [18] B.J. Williams, A.H. Goldstein, N.M. Kreisberg, S.V. Hering, *Aerosol Sci. Technol.* 40 (2006) 627.
- [19] T. Górecki, J. Harynuk, O. Panic, *J. Sep. Sci.* 27 (2004) 359.
- [20] J.F. Hamilton, P.J. Webb, A.C. Lewis, J.R. Hopkins, S. Smith, P. Davy, *Atmos. Chem. Phys.* 4 (2004) 1279.
- [21] Z.Y. Liu, J.B. Phillips, *J. Chromatogr. Sci.* 29 (1991) 227.
- [22] J. Harynuk, T. Górecki, *J. Sep. Sci.* 25 (2002) 304.
- [23] L.M. Blumberg, *J. Chromatogr. A* 985 (2003) 29.
- [24] R.E. Murphy, M.R. Schure, J.P. Foley, *Anal. Chem.* 70 (1998) 1585.
- [25] N.M. Kreisberg, S.V. Hering, B.W. Williams, A.H. Goldstein, *Aerosol Sci. Technol.*, submitted for publication.